

Montageanleitung
Arbeitsscheinwerfer

Mounting Instructions
Work lamps

Instructions de montage
Projecteur de travail

Monteringsanvisning
Arbetsstrålkastare

Montagehandleiding
Werklamp

Instrucciones de montaje
Faro de trabajo

Istruzioni di montaggio
Faro de lavoro

Asennusohje
Työvaloneheitintä



Powerbeam 1000



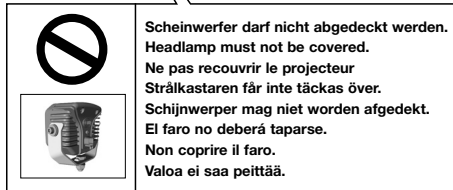
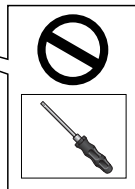
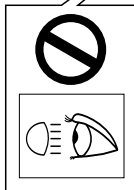

Produkthaftung

- Es sind die nationalen Anbau-, Einbau- und Betriebsvorschriften zu beachten und einzuhalten.
- Lesen Sie bitte vor Gebrauch des Gerätes alle beigelegten Anleitungen und Sicherheitshinweise.
- Im Zuge von Produktverbesserung behalten wir uns technische und optische Änderungen vor.
- Verwenden Sie nur die Originalersatzteile bzw. nur Ersatzteile die von HELLA freigegeben sind.
- Bei Fragen oder Einbauproblemen, rufen Sie den HELLA Kundendienst, Großhändler oder wenden Sie sich an Ihre Vertragswerkstatt.

Product liability

- National mounting, fitting and operating regulations must be heeded and kept.
- Please read all the instructions and safety notes included before using the device.
- We reserve the right to make technical and optical modifications within the course of product improvement.
- Only use original spare parts or spare parts approved by HELLA.
- If you have any questions or installation problems, call HELLA customer services, your wholesaler or contact your specialist garage.

Responsabilité produit

- Les prescriptions nationales en matière de montage et de service doivent être observées et respectées.
- Avant d'utiliser l'appareil lire toutes les instructions de montage et de service fournies ainsi que les conseils de sécurité.
- Dans le cadre de l'amélioration continue de nos produits, nous nous réservons le droit de réaliser des modifications sur les plans technique et optique.
- Utilisez uniquement des pièces d'origine ou des pièces de rechange validées par HELLA.
- Pour tous renseignements ou problèmes de montage, contactez le S.A.V. HELLA, votre distributeur ou votre garage lié par contrat.

Produktansvar

- De nationella monterings-, installations- och driftföreskrifterna ska beaktas och följas.
- Läs alla medföljande instruktioner och säkerhetsanvisningar innan du använder apparaten.
- Vi förbehåller oss rätten till tekniska och optiska ändringar som förbättrar produkten.
- Använd endast original reservdelar resp. endast reservdelar som har godkänts av HELLA.
- Om du har frågor eller problem med installationen, ring HELLA kundtjänst, parthandlaren eller vänd dig till din märkesverkstad.

Productaansprakelijkheid

- Men dient de nationale aanbouw-, inbouw- en bedrijfsvoorschriften in acht te nemen en na te leven.
- Lees a.u.b. alvorens het apparaat te gebruiken alle bijgevoegde gebruiksaanwijzingen en veiligheidsinstructies door.
- In het kader van de productverbetering behouden wij ons technische en optische veranderingen voor.
- Gebruik uitsluitend de originele reserveonderdelen, die door Hella vrijgegeven zijn.
- Bij vragen of inbouwproblemen dient u de HELLA klantenservice, de groothandel te bellen of u te richten tot de dealerwerkplaats.

Responsabilidad civil por productos defectuosos

- Tienen que observarse y cumplirse con las prescripciones nacionales sobre construcciones anexas, de montaje y de funcionamiento
- Rogamos que antes de usar el aparato lean todas las instrucciones y advertencias sobre la seguridad adjuntas.
- En aras de la mejora de los productos, nos reservamos el derecho de hacer modificaciones técnicas y ópticas.
- Use sólo recambios originales o bien sólo recambios autorizados por HELLA.
- Si tiene preguntas que hacernos o dificultades en el montaje, llame al Servicio de Atención al Cliente de HELLA, a los mayoristas o dirijase a su taller concesionario.

Responsabilità per il prodotto

- si devono rispettare tutte le normative nazionali di attacco, montaggio e funzionamento.
- Prima di usare l'apparecchio, legga per favore tutte le istruzioni e le avvertenze di sicurezza allegate.
- Nell'ambito del perfezionamento del prodotto, ci riserviamo modifiche tecniche ed estetiche.
- Utilizzare solo pezzi di ricambio originali risp. pezzi autorizzati dalla HELLA.
- In caso di domande o problemi di montaggio, chiami il servizio di assistenza dei clienti della HELLA, il rivenditore o si rivolga alla Sua officina autorizzata.

Tuotevastuu

- Kansalliset asennus- ja käyttöohjeet on huomioitava ja niitä on noudatettava.
- Lue ennen laitteen käyttöä kaikki oheistetut käyttö- sekä turvaohjeet.
- Jatkuva tuotekehittelystä johtuen pidämme oikeuden teknisiin ja optisiin muutoksiin.
- Käytä vain alkuperäisiä tai HELLA hyväksymiä varaosia.
- Jos Sinulla on kysymyksiä tai asennusongelmia, soita HELLA-asiakaspalveluun, tukkukauppiaille tai kääny sopimuskorjaamoon puoleen.

Lieferumfang
Leveransomfattning
Sostituzione lampadina

Kit includes
Inhoud set
Volumen del suministro

Dotazione di fornitura
Osaluuttelo

4



1GA 996 188-XXX



1GA 996 188-XXX

**Benötigtet Werkzeug
Nödvändiga verktyg
Utensili necessari**

**Tools required
Noodzakelijk gereedschap
Tarvittavat työkalut**

**Outillage nécessaire
Herramientas necesarias**

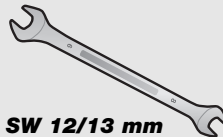
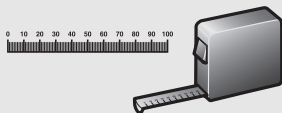

**SW 12/13 mm
SW 16/17 mm**

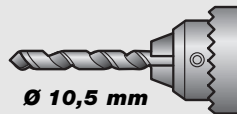
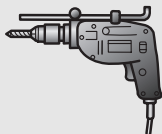

Ø 10,5 mm

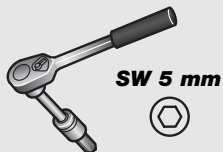

SW 5 mm

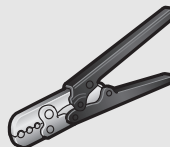

**Montage
Montering
Montaggio**

**Mounting
Montage
Asennus**

**Montage
Montaje**

1GA 996 188-XXX

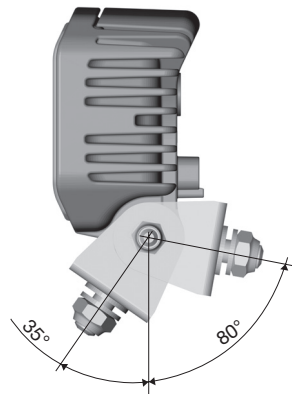
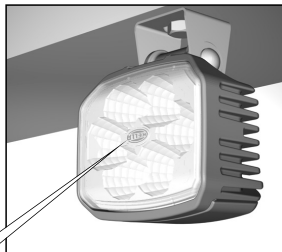
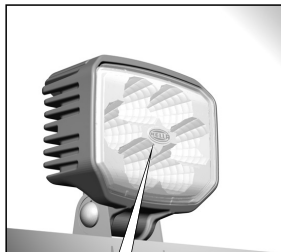

6

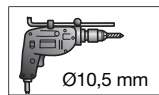

Ø10,5 mm

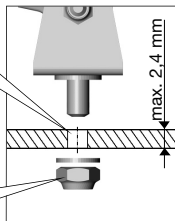

max. 2,4 mm

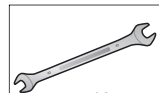

16 mm

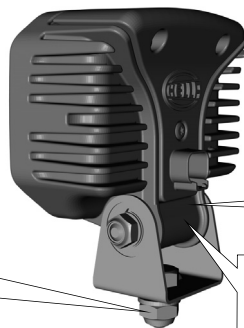

12V / 24V



Siehe Seite 8
See page 8
Cf. page 8
Se sidan 8

Zie pagina 9
Véase página 9
Vedere pagina 9
Katso sivu 9

**Montage
Montering
Montaggio**

**Mounting
Montage
Asennus**

**Montage
Montaje**

1GA 996 188-XXX

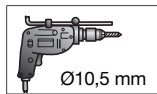
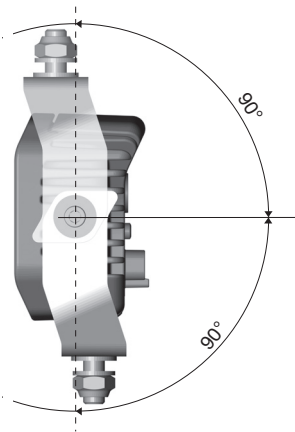
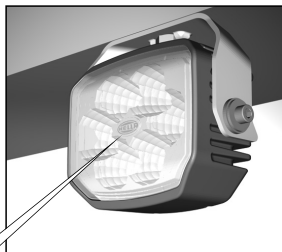

Ø10,5 mm

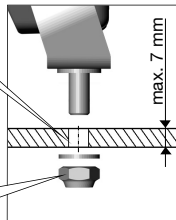

max. 7 mm

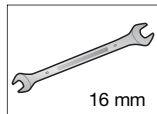

16 mm



12V / 24V



Siehe Seite 8
See page 8
Cf. page 8
Se sidan 8

Zie pagina 9
Véase página 9
Vedere pagina 9
Katso sivu 9

DE Technische Daten

Nennspannung	Spannungsbereich	Eingangswerte	Zulässige Umgebungstemperatur	Schutzklasse IP 6K 9K
12V 24V	9V – 32V 9V – 32V	<700 mA <8,5 W <400 mA <10,2 W	-40° C bis +50° C	(Spritzwasser und Staub geschützt)

Zulässige Leitungslänge max. 10 m nach ECE.

Der Betrieb der Leuchte mit Wechselspannung oder getakteter Gleichspannung ist nicht zulässig!

EN Technical Data

Nominal voltage	Range of voltage	Input values	Admissible ambient temperature	Class of protection IP 6K 9K
12V 24V	9V – 32V 9V – 32V	<700 mA <8,5 W <400 mA <10,2 W	-40°C up to +50°C	(Protection against splash water and dust)

Admissible length of cable max. 10 m in accordance with ECE

Operation of the light using alternating voltage or clocked direct voltage is not permitted!

8

FR Document technique

Tension nominale	Plage de tension	Valeurs d'entrée	Température ambiante admissible	Classe de protection IP 6K 9K
12V 24V	9V – 32V 9V – 32V	<700 mA <8,5 W <400 mA <10,2 W	-40°C à +50°C	(Protection aux projections d'eau et à la poussière)

Longueur de câble admissible maxi. 10 m suivant ECE

Le fonctionnement du feu avec une tension alternative ou une tension continue cadencée n'est pas admis!

SV Tekniska data

Märkspänning	Spänningsområde	Ingångsvärden	Tillåten omgivningstemperatur	Skyddsklass IP 6K 9K
12V 24V	9V – 32V 9V – 32V	<700 mA <8,5 W <400 mA <10,2 W	-40°C upp till +50°C	(Skydd mot stänkvatten och damm)

Tillåten ledningslängd max. 10 m enligt ECE

Lampan får inte användas med växelspanning eller taktad likspanning!

NL Technische Gegevens

Nominale spanning	Spanningsbereik	Ingangswaarden	Toegestane omgevingstemperatuur	Beschermklasse IP 6K 9K
12V	9V – 32V	<700 mA <8,5 W		
24V	9V – 32V	<400 mA <10,2 W	-40°C tot +50°C	(Bescherming tegen spetterend water en stof)

Toegestane kabelengte max. 10m volgens ECE

Het gebruik van de lamp met wisselspanning of getacte gelijkspanning is niet toegestaan!

ES Datos técnicos

Tensión nominal	Margen de tensión	Valores de entrada	Temperatura ambiente admisible	Clase de protección IP 6K 9K
12V	9V – 32V	<700 mA <8,5 W		
24V	9V – 32V	<400 mA <10,2 W	-40°C hasta +50°C	(Protección antisalpicaduras agua y polvo)

Largo máximo admisible del cable 10 m según ECE

¡No es admisible el funcionamiento de las luces con corriente alterna o corriente continua sincronizada!

IT Dati tecnici

Tensione nominale	Intervallo di tensione	Valori di ingresso	Temperatura ambiente ammessa	Categoria di protezione IP 6K 9K
12V	9V – 32V	<700 mA <8,5 W		
24V	9V – 32V	<400 mA <10,2 W	da -40°C a +50°C	(Protezione contro spruzzi d'acqua e polvere)

Lunghezza della linea massima ammessa 10m ai sensi di ECE

Non è consentito attivare i fanali con tensione alternata o tensione continua ciclica!

FI Tekniset tiedot

Nimellisjännite	Jännitealue	Tuloarvot	Sallittu ympäristölämpötila	Kotelointiluokka IP 6K 9K
12V	9V – 32V	<700 mA <8,5 W		
24V	9V – 32V	<400 mA <10,2 W	-40°C ... +50°C	(Suojattu pölyltä ja roiskevedeltä)

Johdon suurin sallittu pituus 10 m ECE mukaan

Valoa ei saa käyttää vaihtojännitteellä eikä tahdistetulla tasajännitteellä!

Elektrischer Anschluß
Elektrisk anslutning
Collegamento elettrico

Electrical connection
Elektrische aansluiting
Sähköliitäntä

Branchement électrique
Conexión eléctrica

10

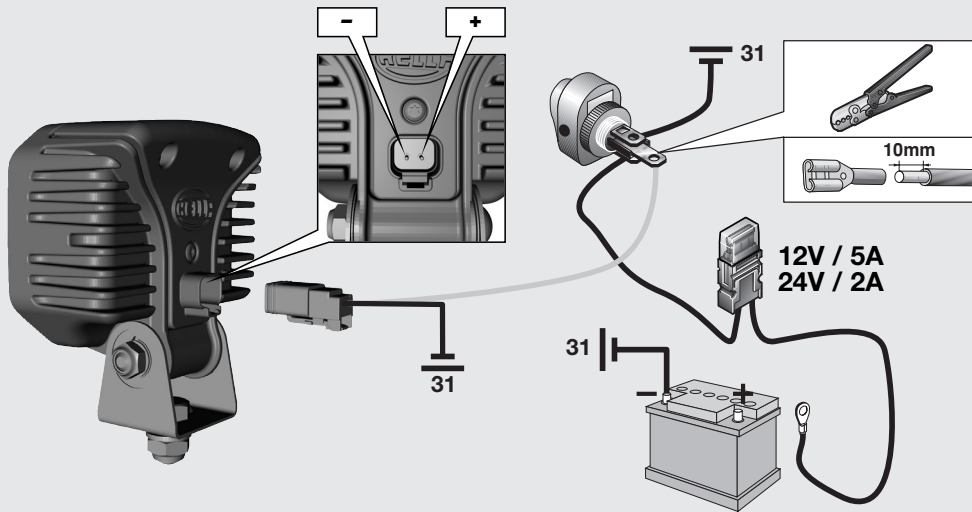

**Zubehör
Tillbehör
Accessori**

**Accessories
Toebehoren
Lisätarvikkeet**

**Accessoires
Accesorios**

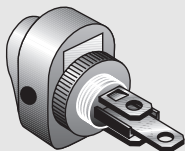

6EH 007 946-001



**5A (12V) : 8JS 711 684-821
2A (24V) : 8JS 711 683-841**

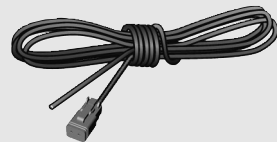

8KB 990 299-011



8JD 005 235-801



8KW 744 697-003

Hella Fahrzeugteile Austria GmbH

Target Group Agricultural, Construction and Utility Machinery
Target Group Power Sports
A-1100 Wien / Vienna Austria

460 879-19 07/10

