

# BMW, MINI, Rolls-Royce

## Retail equipment



- Workshop equipment
- Recommended Beissbarth and Bosch workshop equipment

# Beissbarth – The ideal partner

Beissbarth is a Bosch Group company whose working relationship with the BMW Group stretches back over several decades. The aim has always been to keep workshop equipment up-to-date with the latest developments in automotive engineering, to ensure the best possible service results and maximum profitability. In addition, all products are subject to stringent inspection at the factory and are manufactured to national certification standards. As a result Beissbarth and Bosch equipment is guaranteed to offer the outstanding quality you can expect from leading brands. Tested and recommended by the BMW Group for your service business. Worldwide.

And even after purchasing, customers can continue to rely on Beissbarth for telephone support, a broad service spectrum, a choice of maintenance contracts and prompt spare parts deliveries.

Throughout the world, the Bosch network and more than 90 sales partners are on hand to offer their advice. So you can always count on Beissbarth for after sales support.



## Service advice area

**The immense experience of Beissbarth and Bosch guarantees optimum workshop efficiency as well as maximum profitability and outstanding precision.**

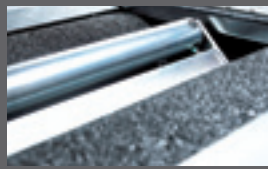

## Vehicle Testing Brake Testers



4-11

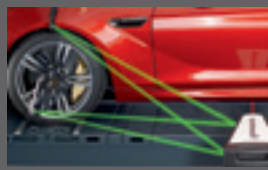

## Wheel Alignment Measurement Bay



12-19

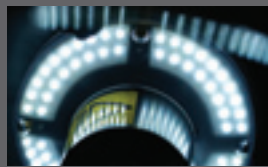

## Wheel Balancers Tyre Changers



20-25



## Air Conditioning Service Equipment



26-31



## Measuring and Adjustment



32-37



## Repair and Tools



38-43



### **BD 620 PC:**

Brake tester with PC visualisation.

6-7

### **SAT 690 / 695:**

Extension of test lane  
to include axle damping tester.

8-9

### **BD 620:**

Brake tester with analogue display.

10-11

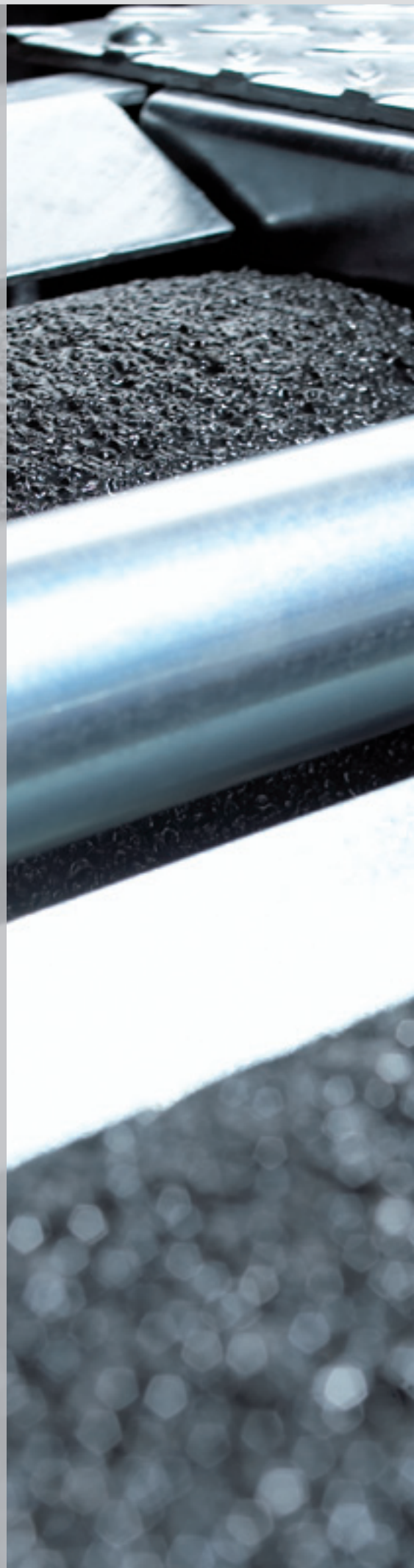

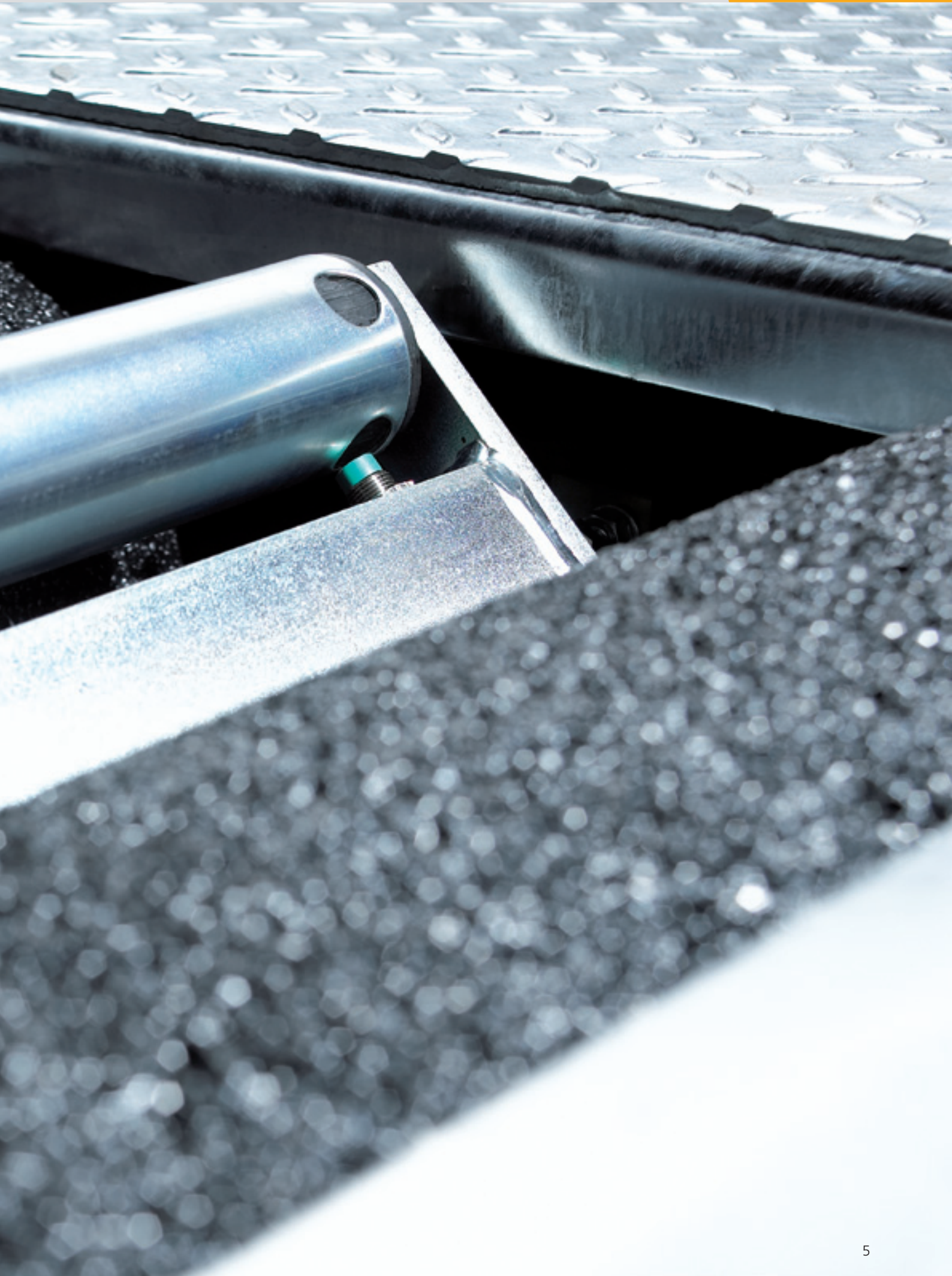

# BD 620 PC: Brake tester with PC visualisation.



## Passenger vehicle brake tester – with PC

- **Automatic operator prompting - no remote control, no keyboard commands**
- **Reference database, vehicle history and guide values**
- **Print-out of vehicle faults with graphical presentation**
- **Flexible line lengths for easy installation in dialog reception areas (even with suspension tester)**
- Up to 4t axle load and track widths of 800 - 2,200 mm
- BNET device bus connects master switch box to roller set and PC trolley
- Control and power electronics integrated into roller set
- Strain gauge measurement system for maximum precision
- Galvanised roller set: Suitable for outdoor installation
- Super automatic mode with test sequence for service and parking brake systems
- Electromagnetic brake for gentle drive-off
- Brake rollers with plastic/corundum coating: Long service life and firm tyre grip
- Rear test roller elevated by 25 mm: Ideal test conditions  
Robust slip roller unit also suitable for drive-through installation

The Beissbarth BD 620 PC is approved for official routine vehicle testing in Germany and certified in accordance with the technical guidelines for brake testers (10/2011):

- ASA livestream interface (LAN) for linking test systems of official test authorities
- Test speed 5.2 km/h compatible with the latest braking systems
- Blockage safety feature combined with robust slip roller unit and extra sensors for brake roller speed
- Prepared for reference braking force value procedure with corresponding database

Recommendations for all European countries.  
Linking to Dealer Management systems by way of optional BNET and ASA network interface.

### Special Accessories:

Roller cover plates (swivel type)	81 32 2 217 490
Roller cover plates (clip-in type)	81 32 2 217 492
Edge protection BD 620 roller set	81 32 2 217 495
BNET licence key #3 (ASA network)	81 32 0 429 278

88

89

90

## Scope of Delivery:

## Technical Data:

Operator console	Roller set modules with 2 x 3.7 kW drive power, 205 mm roller dia., master switch box + inst.materials	Connection data	Test speed	Max. braking force	Axle load weigher
81 32 2 218 034 BD 620 PC BMW PC cabinet (complete) with <ul style="list-style-type: none"> <li>• Power PC with WIN XP</li> <li>• 19" TFT</li> <li>• Colour printer</li> <li>• IR receiver</li> <li>• IR remote control unit</li> <li>• BNET/USB interface</li> <li>• BNET software</li> </ul>	81 32 2 320 963	BD 620 kit with ASA livestream	3x400 V / 50 Hz	5.2 km/h	2x 6.0 kN optional
	81 32 2 320 966	BD 620 kit with ASA livestream	3x400 V / 50 Hz	5.2 km/h	2x 6.0 kN ✓
	81 32 2 217 470	BD 620 kit	3x220 V / 60 Hz	2,7 km/h	2x 7.5 kN optional
	81 32 2 217 481	BD 620 kit	3x220 V / 60 Hz	2.7 km/h	2x 7.5 kN ✓
	81 32 2 217 483	BD 620 kit	3x400 V / 50 Hz	5.2 km/h	2x 6.0 kN optional
	81 32 2 217 485	BD 620 kit Steel rollers for spiked tyres	3x400 V / 50 Hz	2.7 km/h	2x 7.5 kN optional

## Special Accessories:



81 32 2 352 370

Pedal force sensor



BB-Nr: 1 691 602 115

Installation box for roller set



81 32 0 429 075

4-point weigher as supplementary equipment set, for automatic calculation of axle weight and total deceleration



81 32 2 217 499

Pit edge protection

# SAT 690 / 695: Extension of test lane to include axle dampin

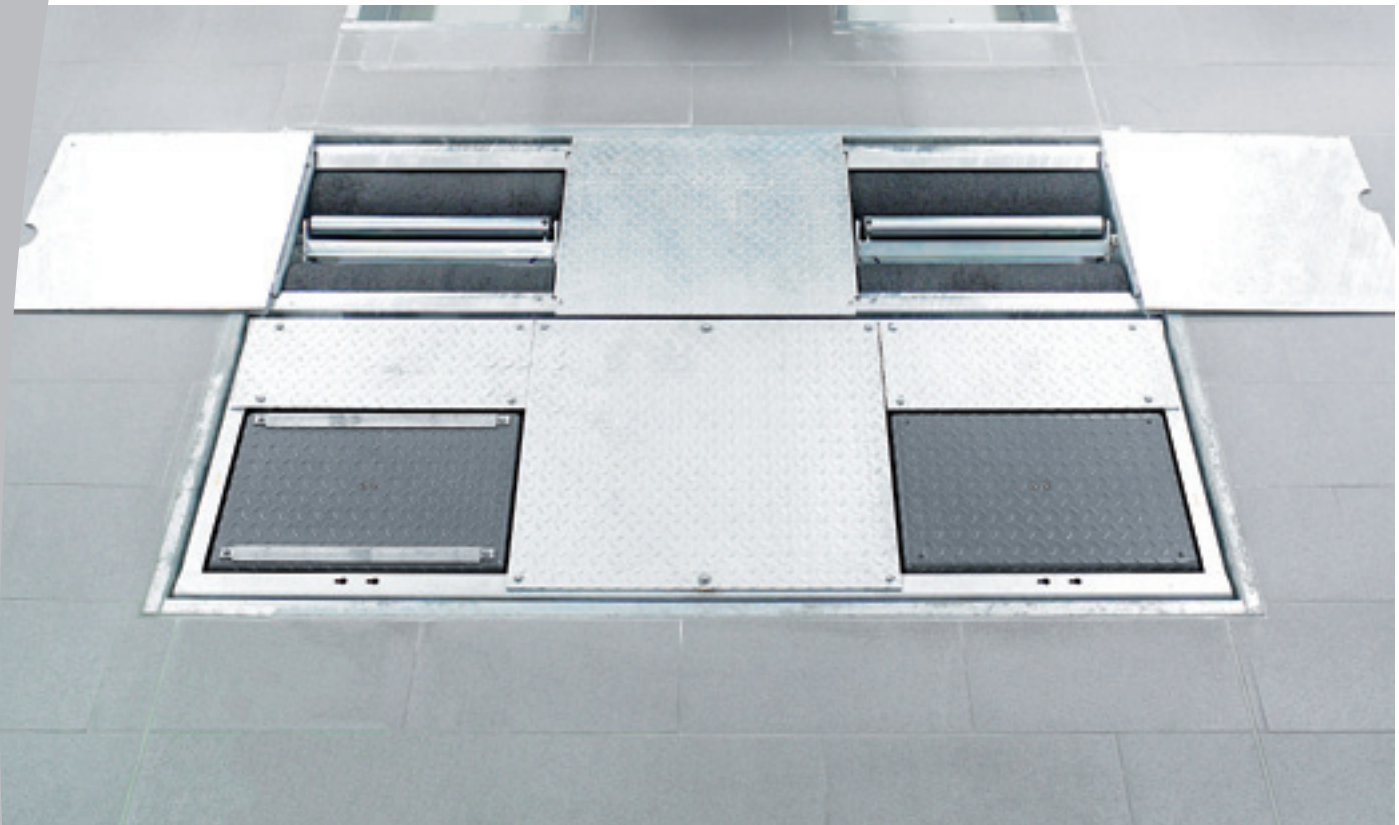

## Theta axle damping testers based on the Boge principle (damping factor)

- Indirect shock absorber testing based on the Theta principle with high repeatability
- Limit value display for qualification of damping components and corresponding replacement recommendation
- Linking of tester to BD 620 PC by way of BNET device bus.
- Automatic determination of axle and vehicle weight, adoption of weight for calculation of deceleration on brake tester
- Print-out with clear graphical representation of any vehicle faults

- Reference database with vehicle history and generally applicable guide values
- SAT 695 with additional noise detection diagnosis module for determination of body and interior noise. Advantage: No need for road tests

Theta axle damping testers from Beissbarth operate on the resonance principle. This involves analysing the energy levels in the entire vibrating system (wheels, axle and body) during application of the resonant frequency. The Lehr's damping ratio („D“) is determined by way of physical evaluation. This measurement principle is considered to be extremely accurate in workshop practice, as confirmed by comprehensive studies and reference tests.

## Scope of Delivery:

### Theta axle damping tester based on the Boge principle (damping factor)

### Technical data

81 32 2 217 496	SAT 690	3 x 400 V / 50 Hz
81 32 2 217 498	SAT 695 With noise detection diagnosis	3 x 400 V / 50 Hz



g tester.



### Technical Data:

Testable axle load	2.2 t
Max. driveover load	2.5 t
Drive power	2 x 1.1 kW
Excitation stroke	6.5 mm
Excitation frequency	2 - 10 Hz
Max. plate stroke	ca. 70 mm
Min. track width	800 mm
Max. track width	2,200 mm
Lehr's damping ratio "D" measuring range	0.02 - 0.3
Dimensions (L x W x H)	2,320 x 800 x 280 mm

### Special Accessories:

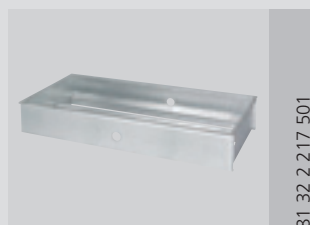

81 32 2 217 501

Installation box for test lane



81 32 2 217 499

Pit edge protection

# BD 620: Brake tester with analogue display.



## Scope of Delivery:

## Technical Data:

Universal analogue display	Roller set modules with 2 x 3.7 kW drive power, 205 mm roller dia., master switch box and installation materials	Connection data	Test speed	Max. braking force	Axle load weigher
81 32 2 217 487 BD 620 Universal analogue display with <ul style="list-style-type: none"> <li>• 3-coloured evaluation scale</li> <li>• LCD (2x4-digit and 1x5-digit)</li> <li>• Braking force dial with 2 x 8 kN scale</li> <li>• IR receiver</li> <li>• IR remote control unit</li> </ul>	81 32 2 320 963 BD 620 kit with ASA livestream	3x400 V / 50 Hz	5.2 km/h	2x 6.0 kN	optional
	81 32 2 320 966 BD 620 kit with ASA livestream	3x400 V / 50 Hz	5.2 km/h	2x 6.0 kN	✓
	81 32 2 217 470 BD 620 kit	3x220 V / 60 Hz	2.7 km/h	2x 7.5 kN	optional
	81 32 2 217 481 BD 620 kit	3x220 V / 60 Hz	2.7 km/h	2x 7.5 kN	✓
	81 32 2 217 483 BD 620 kit	3x400 V / 50 Hz	5.2 km/h	2x 6.0 kN	optional
	81 32 2 217 485 BD 620 kit Steel rollers for spiked tyres	3x400 V / 50 Hz	2.7 km/h	2x 7.5 kN	optional

### Passenger vehicle brake tester – with universal analogue display

- **Flexible and efficient for diagnosis and customer information**
- **Extra-flat analogue display with BNET device bus connection for flexible installation**
- **Extremely clear presentation of total deceleration and braking force difference**
- **With multi-coloured scale to indicate vehicle faults**
- No bulky control cabinet required thanks to integration of control and power electronics in roller set
- Up to 4 t axle load and track widths of 800 - 2,200 mm
- Strain gauge measurement system for maximum precision
- Galvanised roller set: Suitable for outdoor installation
- Super automatic mode with test sequence for service and parking brake systems
- Electromagnetic brake for gentle drive-off
- Brake rollers with plastic/corundum coating: Long service life and firm tyre adhesion
- Rear test roller elevated by 25 mm: Ideal test conditions even for tyre sizes of up to 28"
- Robust slip roller unit also suitable for drive-through installation

The Beissbarth BD 620 is approved for official routine vehicle testing in Germany and certified in accordance with the technical guidelines for brake testers (10/2011):

- ASA livestream interface (LAN) for linking test systems of official test authorities
- Test speed 5.2 km/h compatible with the latest braking systems
- Blockage safety feature combined with robust slip roller unit and extra sensors for brake roller speed
- Prepared for reference braking force value procedure with corresponding database

Recommendations for all European countries.  
Linking to Dealer Management systems by way of optional BNET and ASA network interface.

#### Special Accessories:

Wall mount	81 32 2 217 488
Stand	81 32 2 217 489
Roller cover plates (swivel type)	81 32 2 217 490
Roller cover plates (clip-in type)	81 32 2 217 492
Edge protection	81 32 2 217 495
4-point weigher supplementary equipment set	81 32 0 429 075

### Special Accessories:



Installation box for roller set

BB-Nr: 1 691 602 115



Pedal force sensor

81 32 2 352 370



Pit edge protection BD 620 roller set

81 32 2 217 495



BNET printer set. For print-out of measurement results in tabular form on fan-fold paper

81 32 0 429 275



Printer cabinet for wall mounting

81 32 2 217 493



USB converter set for connection of BD 620 to existing PCs, BNET software incl. printer software, archiving software and order manager

81 32 0 429 277



### **KDS II Wheel Alignment:**

Precision wireless CCD technology.

14-15

### **KDS 3D Wheel Alignment:**

With 3D technology.

High speed, high precision and easy to use.

16-17

### **VLH 4440 4-post lift:**

The ideal measurement bay for wheel alignment.

Fully prepared for KDS 3D and KDS II.

18-19





# KDS II Wheel Alignment: Precision wireless CCD technology.



The CCD camera technology developed by Beissbarth is at the heart of the wheel alignment system. This is the third generation of KDS II featuring precision technology to perfection.

#### Beissbarth sensors:

- Each of the four sensors has two CCD infrared cameras with their own processor
- Complete 360° precision measurement field all around the vehicle
- Permanent system monitoring
- Additional rear axle measurement options such as setback and axle offset
- Heavy-duty batteries guarantee 12 hours of problem-free continuous operation

#### Beissbarth CCD cameras:

- Extended toe measuring range
- Integrated, finely adjusted camber pendulums
- Caster measurement with 20° steering angle

#### Data transfer:

- Wireless transmission: KDS II transfers data from the sensor to the PC without the need for cables (433 MHz or 2.4 GHz)
- With ASA network interface as standard

**Thanks to the BMW quick clamps**, there is no need for wheel run-out compensation as these are fitted to the true running surface of the wheel hub.

- For passenger vehicles with 850 mm max. wheel diameter
- BMW precision aluminium turntable bases with electronic pulse generator** permit measurement of the full steering lock positions as well as implementation of the steering angle routine for determining the toe-out on turns in one-man operation.

- Loadbearing capacity 1,000 kg
- Slide range  $\pm 50$  mm
- Angle of rotation - 360°
- Dimensions: 450 x 450 x 50 mm (L x W x H)

#### Choice of three specific measurement routines for BMW:

- Program-driven, quick measurement, random access for checking individual values
- Original BMW measurement protocol
- With tyre check protocol

#### Convenient working:

- Large live measured value display on PC monitor
- Simultaneous display of vehicle specified data
- Animated instructions for other vehicle makes
- Comprehensive database containing specified values for more than 130 different vehicle makes as standard (online update)

## Special Accessories:



81 33 9 428 477

Mobile accessories trolley:  
For transportation and storage of turntables, wheel clamps, ballast bags etc.



81 33 9 429 110

Calibration device  
Toe and camber adjustment can be checked and calibrated by way of adjustment routine



81 33 2 166 967

Multi-Quick clamp  
Clamping range: 13"-24"



BMW quick clamp

**Scope of Delivery:**

- KDS II (433 MHz) 81 33 0 404 055**
- KDS II (2,4 GHz) 81 33 2 217 509**



- PC trolley with 19" TFT, with networking capability, keyboard, multi-function colour printer, DVD R/W drive and charging modules for sensors
- BMW program software and specified data licence
- IR remote control
- Sensors with digital CCD camera technology and wireless data transfer with integrated battery set (4x)
- BMW quick clamps (4x)
- Precision aluminium turntable bases (2x) with electronic pulse generator and sensor connecting cable
- Precision aluminium turntable bases (2x) for rear axle
- Protective rubber covers for turntables
- Set of screws for fixing turntables in position on lifting platform
- Steering wheel holder and brake pedal clamp
- Precision spoiler adapter 50 mm with spirit level:

Measurement options	Measurement accuracy	for measured value range
1. Total toe (front axle + rear axle)	± 3'	± 2°
2. Individual toe (front axle + rear axle)	± 2'	± 2°
3. Camber (front axle + rear axle)	± 2'	± 3°
4. Setback (front axle + rear axle)	± 2'	± 2°
5. Thrust line	± 2'	± 2°
6. Caster	± 4'	± 18°
7. Steering axis inclination	± 4'	± 18°
8. Toe-out on turns	± 4'	± 20°
9. Caster correction range	± 4'	± 7°
10. Wheelbase difference	± 3'	± 2°
11. Left/right side offset	± 2'	± 2°
12. Toe width difference	± 3'	± 2°
13. Axle offset (rear axle)	± 3'	± 2°

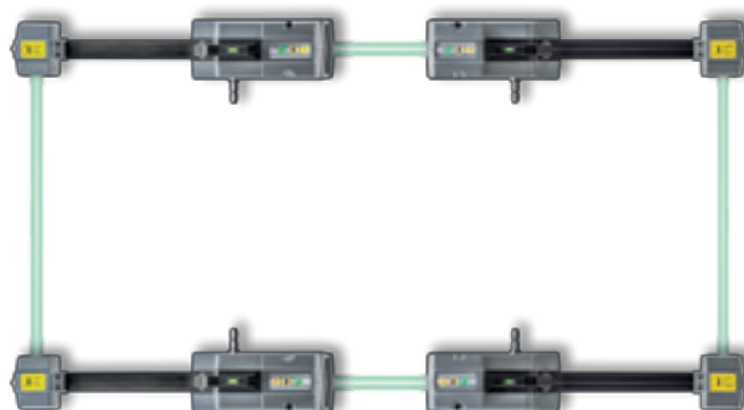

# KDS 3D Wheel Alignment with 3D technology: High speed, high precision and easy to use.



## KDS 3D – optimised 3D technology with permanent level measurement.

The KDS 3D sets new standards in terms of professional wheel alignment to BMW Group specifications. Finely adjusted 3D technology with triangulation for each wheel and the use of ride height markers is the key to high measurement and repeat accuracy. The accurate determination of measured values is guaranteed by the Beissbarth stereo camera measurement system and CCD reference cameras in combination with sophisticated software: Toe and camber accurate to  $\pm 2$  angular minutes. Further features:

- Integrated reference system: No calibration required
- Impact-resistant, lightweight portable sensors

- No space required in front of or behind the lifting platform
- Passenger vehicles and light trucks with wheelbases between 1,800 and 3,400 mm
- Optional large rear axle measurement boards for wheelbases up to 4,300 mm

## 1 minute set-up time thanks to new magnetic holders for measurement paddles:

- Convenient alternative to universal holder
- Quick and easy positioning on wheel bolts
- For magnetic wheel bolts with sufficiently flat surface
- For rims with the following hole circles:
  - 3-hole rim 98.0 - 112.0 mm dia.
  - 4-hole rim 98.0 - 130.0 mm dia.
  - 5-hole rim 98.0 - 139.7 mm dia.

## Special Accessories:

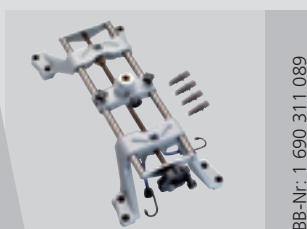

BB-Nr.: 1 690 311 089

4 multi-Fit universal holder



BB-Nr.: 1 690 311 114

4 adapters for Softline rims



BB-Nr.: 1 690 701 032

2 large measurement boards (Rolls-Royce)



81 33 9 428 477

Mobile accessories trolley for turntables, wheel clamps, ballast bags, etc.





### Convenient initial measurement:

- Quick and easy live level measurement with ride height markers attached by way of adhesive pads
- Rolling or driving run-out for calibration at ground level

### Choice of three specific measurement routines for BMW:

- Program-driven, quick measurement, random access for checking individual values
- Original BMW measurement protocol
- Additional tyre check protocol

### Convenient working:

- Automatic specified value adaptation thanks to permanent level measurement
- Stable measured values at any height: The KDS 3D sensors move up with the platform
- Large live measured value display on PC monitor
- Simultaneous display of vehicle target data
- Animated repair instructions also included for non BMW vehicles

### Scope of Delivery:

#### KDS 3D

81 33 2 185 102

- PC trolley with 19" TFT, keyboard, multi-function colour printer, DVD RW drive
- BMW program software and specified data licence
- 3D sensor heads (2x)
- 3D measurement boards (4x)
- Magnetic holders with short and long magnetic bolts (4x)
- Set of 4 ride height markers
- Set of 2 ride height markers (for MINI/Z3)
- Platform adapters (2 measurement positions)
- Precision aluminium turntable bases (4x) with two alu filling bars each
- Steering wheel holder and brake pedal clamp
- Set of screws for fixing turntables in position on lifting platform

**Note:** Option for installation on 4-post lift:

Order 15 m cable set. Comprehensive database containing specified values for more than 130 different vehicle makes as standard (online update)

Measurement options	Measurement accuracy	for measured value range
1. Total toe (front + rear axle)	± 4'	± 2°
2. Individual toe (front + rear axle)	± 2'	± 2°
3. Camber (front + rear axle)	± 2'	± 3°
4. Setback (front + rear axle)	± 2'	± 2°
5. Thrust line	± 2'	± 2°
6. Caster	± 4'	± 18°
7. Steering axis inclination	± 4'	± 18°
8. Toe-out on turns	± 4'	± 20°
9. Caster correction range	± 4'	± 7°
10. Wheelbase difference	± 3'	± 2°
11. Left/right side offset	± 3'	± 2°
12. Toe width difference	± 3'	± 2°
13. Axle offset (rear axle)	± 3'	± 2°
14. Full steering lock	± 4'	± 43°

### Included in scope of delivery:

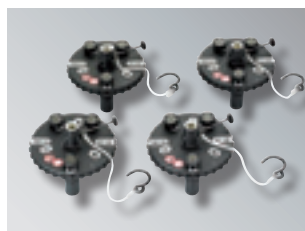

4 magnetic holders



4 ride height markers



2 sensor heads

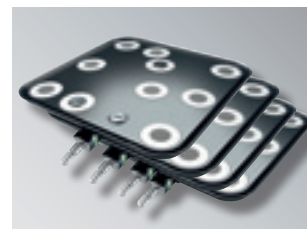

4 measurement boards

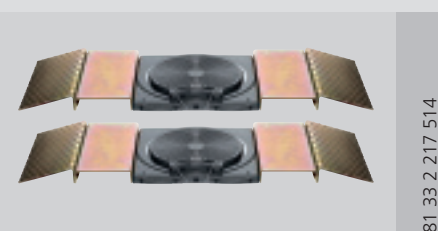

2 extended locating rails for turntables (tt. not incl.)



IR remote control unit



Set of spare adhesive pads for ride height markers



Cable set 15 m  
Cable set 25 m (BB-Nr: 1 690 701 163)

# VLH 4440 4-post lift: The ideal measurement

## Fully prepared for KDS 3D and KDS II.

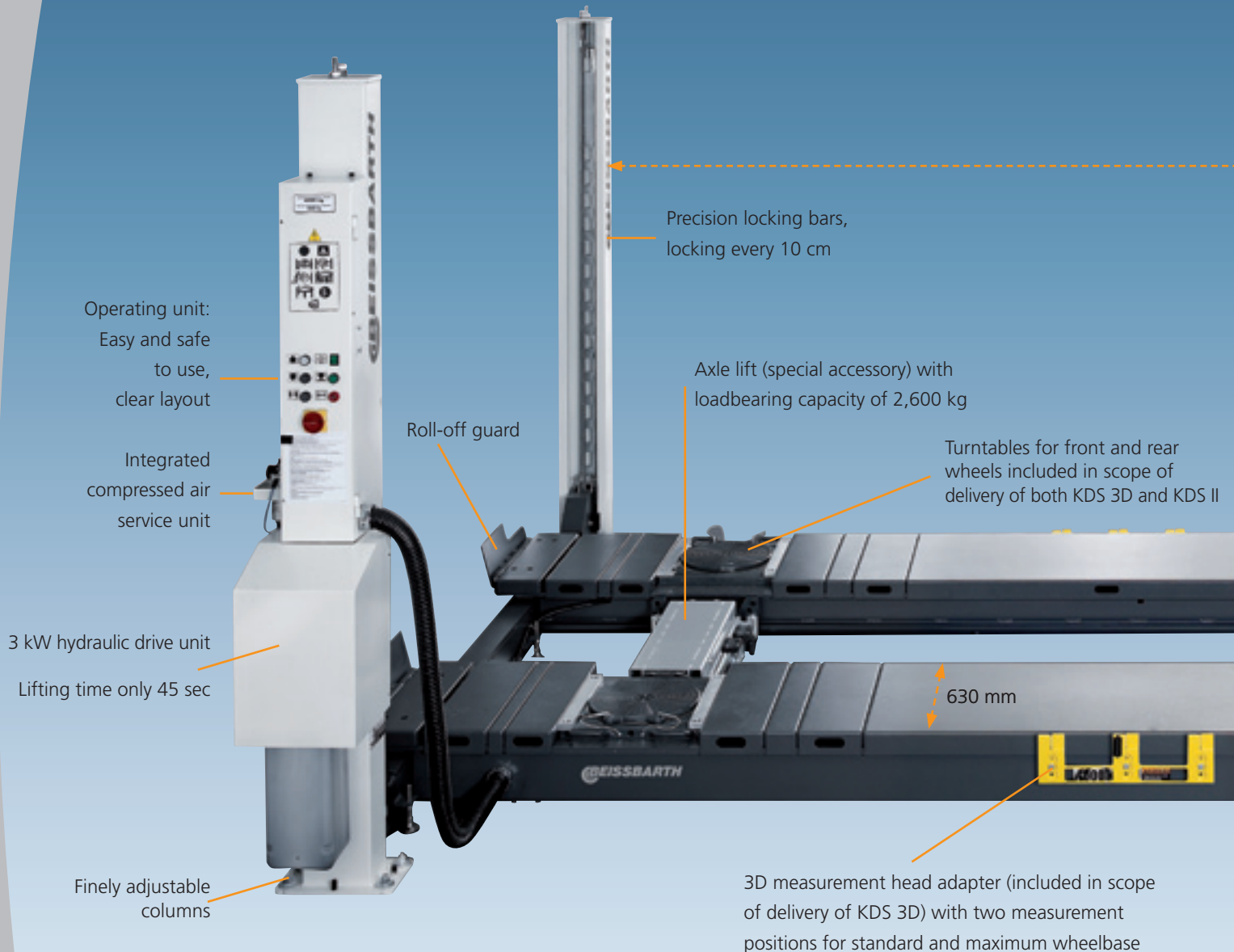

### 4-post lift with electrohydraulic drive with load-bearing capacity up to 4,000 kg for elevated installation in accordance with BMW Group specifications:

- Heavy-duty design (net weight 2,600 kg) for guaranteed stability and outstanding accuracy
- Extra-wide cross member for 3 m column spacing
- Locking mechanism for wheel alignment as standard
- Fine adjustment of runways with respect to cross member
- Runway geometry specially designed for BMW and MINI
- Specific drilling pattern in runways for mounting fillers or pinning turntables

### Technical Data:

4-post lift with electrohydraulic drive, recommended by BMW

Dimensions	6,351 x 3,623 x 2,324 mm
Power supply	3 x 230 V / 50 Hz, E+N / 16 A
Loadbearing capacity	4,000 kg
Max. lifting height	1,920 mm
Lifting time	45 Sek
Runway length	4,700 mm
Longitudinal column spacing (floor plate-floor plate)	4,285 mm
Runway width	630 mm
Clear width	2,940 mm
Distance between runways	950 mm

# bay for wheel alignment.

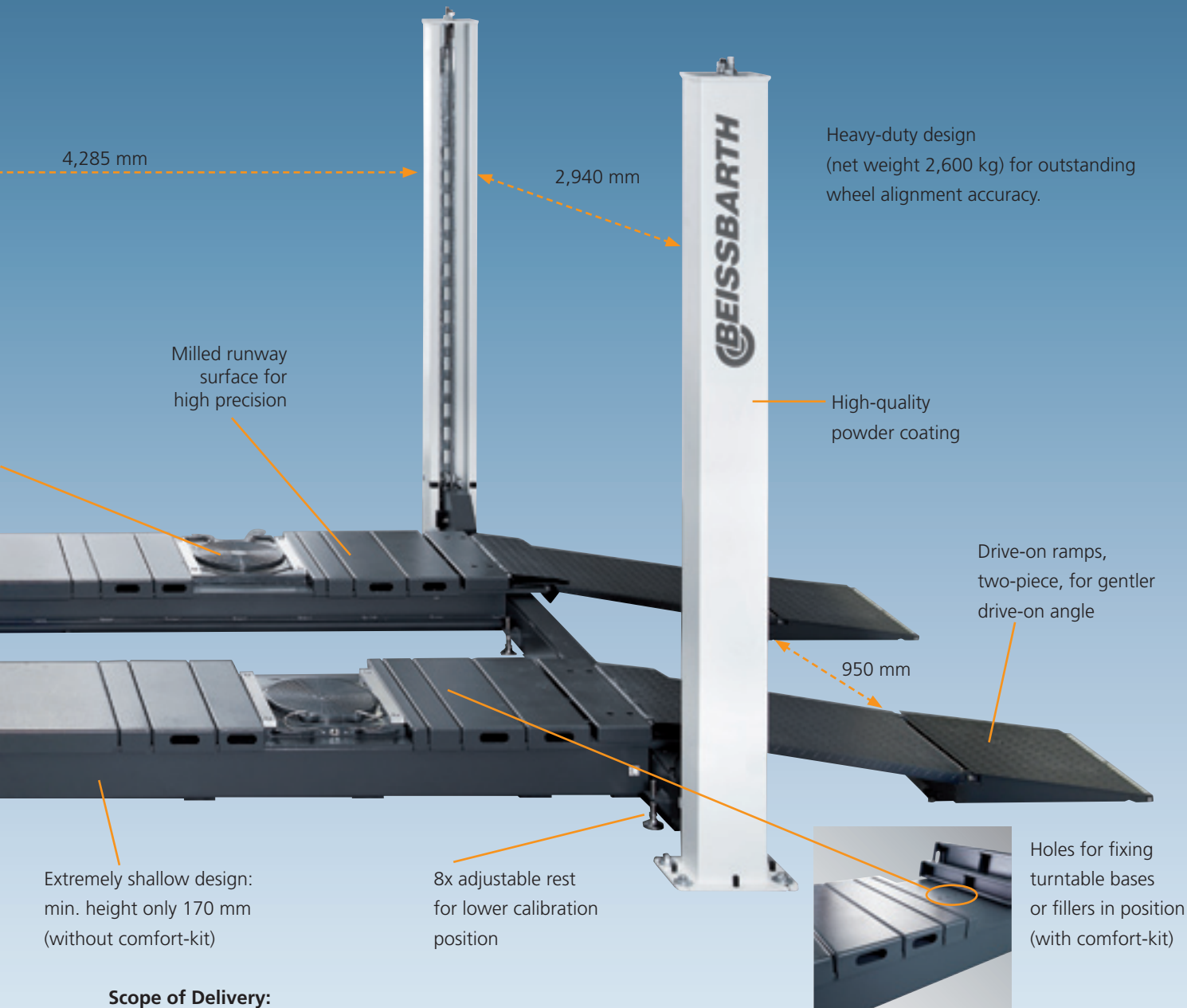

Heavy-duty design (net weight 2,600 kg) for outstanding wheel alignment accuracy.

High-quality powder coating

Drive-on ramps, two-piece, for gentler drive-on angle

950 mm

Holes for fixing turntable bases or fillers in position (with comfort-kit)

Extremely shallow design: min. height only 170 mm (without comfort-kit)

8x adjustable rest for lower calibration position

**Scope of Delivery:**

- 4-post lift
- Operating unit for machine control
- Adapter for KDS 3D sensor head
- Drilling pattern in runways
- Drive-on ramps, long, two-piece (2x)
- Roll-off guards (2x)
- Test log book

**VLH 4440**

Comfort-kit VLH 4440 (Please order separately )

81 21 2 352 844

81 21 2 352 845

**Special Accessories:**

Lighting kit	81 21 2 352 846
Axle lift	81 21 2 352 847

**The VLH 4440 „comfort-kit“**

**Guarantees the level of precision and efficiency required by BMW for wheel alignment with KDS 3D**

- Flat runways with integrated turntables for front and rear wheels

**Configuration for 2,000 - 3,600 mm wheelbases possible**

- Fillers of different lengths for flexible use

**Convenient drive-on - maximum safety and no noise nuisance**

- Fillers with integrated grip
- Fillers pinned to runway and with additional groove on one side



### MT 848 AD:

With new, brilliant digital colour display.

Wheel balancing in 6 seconds.

22

### MT 868 ADT:

Large 19" TFT monitor.

Wheel balancing in 6 seconds.

23

### MT 868 ADPT:

With pneumatic clamping flange.

Wheel balancing in 6 seconds.

24

### MS 680:

Tyre changing for all wheels.

The premium model.

25

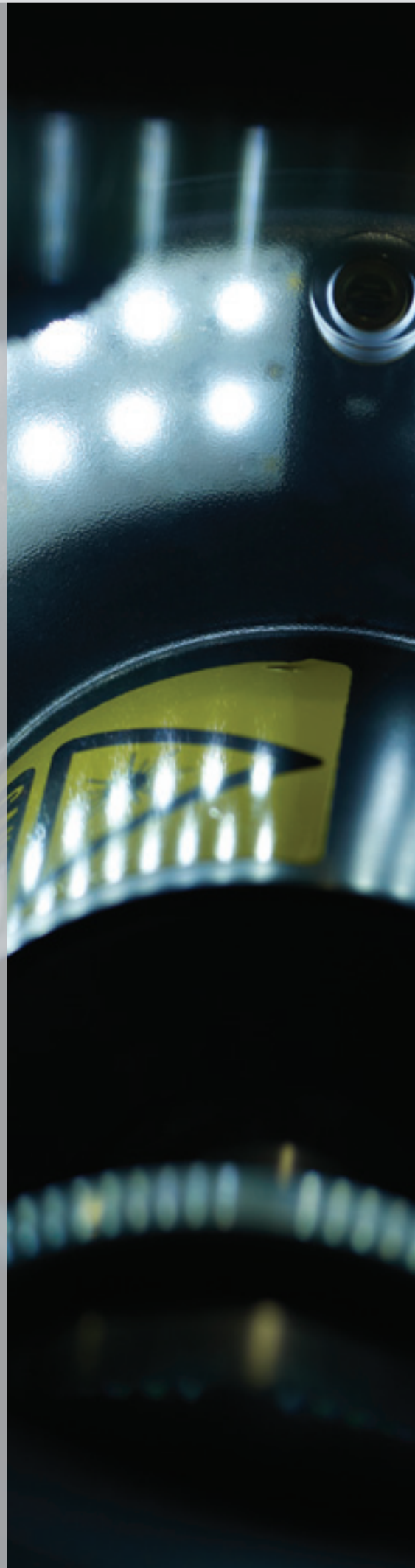

A close-up, low-angle shot of a wheel balancer's sensor array. The array consists of a grid of numerous small, bright, circular sensors arranged in a curved pattern. The lighting is dramatic, with the sensors glowing against a dark background, creating a sense of depth and precision. The overall color palette is dominated by deep blues and blacks, with the bright white light of the sensors providing a strong contrast.

Explanatory notes on Beissbarth wheel balancer product names:

Key:

**A** = With Outer **A**rm

**D** = Easyfix® **D**ata Arm

**P** = **P**neumatic Clamping Flange

**T** = **T**FT Screen

# MT 848 AD: Wheel balancing in 6 seconds. With new, brilliant digital colour display.



The MT 848 AD is a new development from Beissbarth for OEM customers designed for quick and convenient wheel balancing on cars, motorcycles and vans in just six seconds. A touch-sensitive keypad is provided for data input and function control. Weight sizes are shown on the sturdy double LED display. LED arrows indicate the correction positions.

**MT 848 AD**

**81 24 2 352 850**



## MT 848 and MT 868 variants:

### Special Accessory:



#### Wheel lift

**81 24 2 352 851**

For attachment to the side of the wheel balancer; convenient raising and lowering of platform by way of two foot pedals.

Loadbearing capacity	70 kg
Lifting height	500 mm
Length of platform	700 mm
Width of platform	380 mm
Raising time	~ 6 s
Lowering time	~ 8 s
Compressed air supply	6/8 bar

#### Product features:

- Including mounting pins on side for clamping tools
- Foot pedal brake for fixing shaft in position when clamping wheels or for unbalance correction
- Included in scope of delivery: Light and laser ring for internal illumination of rim and to facilitate attachment of balance weights

The enhanced electronic data arms permit quick and accurate determination of rim distance, rim width and rim diameter, thus speeding up the entire measurement procedure. All concealed adhesive weights are also extremely easy to attach thanks to the improved Easyfix® data arm.

#### Important

To achieve optimum balancing results it is essential to ensure that wheels are correctly centred when clamped on wheel balancers. This is certain to be the case if use is made of the specific BMW balancing flange, as the wheels are clamped to the wheel balancer by way of the wheel bolt holes in the rim.

# MT 868 ADT: Wheel balancing in 6 seconds. Large 19" TFT monitor model.

The newly developed measurement unit of the MT 868 ADT permits quick and easy balancing of car, motorcycle and van wheels in six seconds. The software is based on an embedded Windows system and features the familiar, user-friendly graphics interface on a large 19" TFT screen. The new keypad has programmable keys for customised functions.

The software can be used in 22 different languages: Italian, French, English, German, Spanish, Portuguese, Czech, Polish, Hungarian, Slovene, Dutch, Serbian, Finnish, Turkish, Croatian, Swedish, Lithuanian, Russian, Hebrew, Bulgarian, Slovak, Danish.

## MT 868 ADT

81 24 2 352 852



Automatic selection of test routines



Concealed attachment of adhesive weights behind spokes



Easyfix® data arm



Position laser and light ring



Basic flange



Specific BMW balancing flanges, centring pins, centring rings

- Balancing in six seconds with automatic wheel brake
- Exact positioning of all concealed adhesive weights with Easyfix® data arm – stops on reaching the appropriate correction level
- Balancing program function – the most frequently used programs can be accessed directly without additional input
- Split program for accurate positioning of weights behind spokes
- Matching program with operator prompting
- Space-saving wheel hood

### Scope of Delivery:

- Centring flange and additional specific BMW clamping tools
- Basic flange with centring cone set for centre hole 42-111.5 mm
- 2 model-specific flange plates with pins:
  - Hole circle: 4 x 100 mm
  - Hole circles: 5 x 120 mm, 5 x 112 mm
- 2 centring rings dia. 56.0 / 66.5 or dia. 72.5 / 74.0 mm

### Technical Data:

Power supply	1 x 230 V 50 - 60 Hz
Rim width	1 - 27"
Max. wheel width	500 mm
Rim diameter	12 - 30"
Max. wheel diameter	1,150 mm
Max. wheel weight	80 kg

# MT 868 ADPT: Wheel balancing in 6 seconds. With pneumatic clamping flange.



- Balancing in six seconds with automatic wheel brake
- Exact positioning of all concealed adhesive weights with Easyfix® data arm – stops on reaching the appropriate correction level
- Balancing program function – the most frequently used programs can be accessed directly without additional input
- Split program for exact positioning of weights behind spokes
- Integrated matching program with operator prompting
- Space-saving wheel hood
- Including mounting pins on side for clamping tools
- Foot pedal brake for fixing shaft in position when clamping wheels or for unbalance correction

The newly developed measurement unit of the MT 868 ADPT permits quick and easy balancing of car, motorcycle and van wheels in six seconds. The software is based on an embedded Windows system and features the familiar, user-friendly graphics interface on a large 19" TFT screen. The new keypad has programmable keys for customised functions.

The software can be used in 22 different languages. The enhanced electronic data arms permit quick and accurate determination of rim distance, rim width and rim diameter, thus speeding up the entire measurement procedure. All concealed adhesive weights are also extremely easy to attach thanks to the improved Easyfix® data arm. The standard light ring ensures good interior illumination of the wheel centre, in which the optimum weight position is indicated by means of a laser line.

## MT 868 ADPT

81 24 2 352 853

### Scope of Delivery:

- Pneumatic clamping flange
- Additional specific BMW clamping tools
- Basic flange with centring cone set for centre hole 42-111.5 mm
- 2 model-specific clamping plates with pins:
  - Hole circle: 4 x 100 mm
  - Hole circles: 5 x 120 mm, 5 x 112 mm
  - 2 centring rings dia. 56.0 / 66.5 or dia. 72.5 / 74.0 mm

### Technical Data:

Power supply	1 x 230 V 50 - 60 Hz
Rim width	1 - 27"
Max. wheel width	500 mm
Rim diameter	12 - 30"
Max. wheel diameter	1,150 mm
Max. wheel weight	80 kg



Control panel



Basic flange

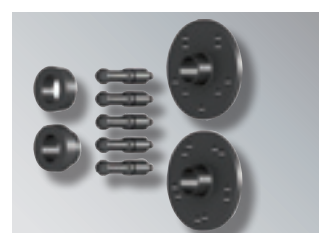

Specific BMW balancing flanges with centring pins and centring rings



# MS 680: Tyre changing for all wheels. The premium model.



Controlled secondary stroke of bead breaker rollers

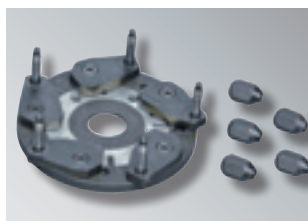

Included in scope of delivery:  
5-hole universal flange for damage-free clamping by way of wheel bolt holes and for wheels with reverse drop centre



Wheel lift for quick and easy positioning of all types of wheel on clamping chuck

The MS 680 is the new premium tyre changer for all UHP and run-flat tyres. Franchised workshops in the premium segment are the target group for this special machine. Advantages such as a locking automatic demounting head, pneumatic centring clamping flange, synchronised adjustable bead breaker rollers with „secondary stroke“, wheel lift, remote control machine operation and a low machine body all make this model a real highlight in any workshop.

- New innovative machine concept
- Convenient fully automatic working; no need for tyre lever
- Pedal for infinitely variable adjustment of speed of rotation
- Wheel lift for simple positioning of all types of wheel on clamping chuck, suitable for wheels up to 80 kg
- Pneumatic clamping chuck for quick and reliable wheel holding
- Enhanced centring through the use of cones (dia. 40-125 mm) and exchangeable plastic guard
- Two separate pneumatically controlled bead breaker rollers for unseating without re-clamping wheel
- Controlled secondary stroke of bead breaker rollers for pressing bead into rim well
- Ergonomically designed mobile operating unit for machine control
- RFT auxiliary arm for fitting in conformity with wdk
- Quick inflator (booster)

**MS 680**

**81 25 2 326 650**

### Scope of Delivery:

- Pneumatic centring with pin and quick-action clamping nut
- Steel cones with plastic guard (dia. 44 - 125 mm)
- 5-hole universal flange
- Wheel lift for wheels up to 80 kg
- Tyre inflator
- wdk plastic disassembly tool
- Plastic guard for rim flange

### Technical Data:

Compressed air connection	8 - 10 bar
Power supply	1 x 230 V / 50 - 60 Hz
Rim diameter	12" - 30"
Rim width	3" - 15"
Max. wheel diameter	1.200 mm
Max. bead breaking force	12.000 N



## BAC 4100a

Fully-automatic AC service unit for R134a.

Maximum precision – easy operation.

28-29

## BAC 5100yf

AC service unit for R1234yf.

Integrated refrigerant identifier.

30-31



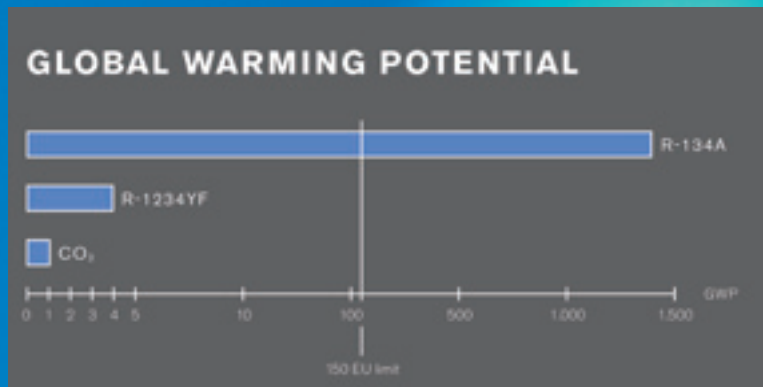

New refrigerant R1234yf reduces global warming effect.



# BAC 4100a: Fully-automatic AC service unit for Maximum precision – easy operation.



**The new fully-automatic Beissbarth AC service unit recovers, recycles and refills R134a refrigerant. Serves standard, hybrid and fully electric vehicle systems.**

#### **Fully-automatic:**

- Recovery function
- Vacuum function
- Leak test
- Air purge function
- Clean oil injection (separate bottles for PAG and POE oil)
- UV dye injection
- Refrigerant charge function

#### **Additionally included:**

- Hose clearing function
- Oil drain function with electronic scale
- Internal air flow control
- Windows Embedded CE
- Flushing function (optional flushing kit)

**As an alternative to fully automatic all steps can be selected individually for a manual controlled sequence.**

#### **Fully-automatic, high-capacity and comfortable:**

The AC service unit manages automatically all maintenance steps including recovering, vacuuming and charging of oil and refrigerant automatically. The 5,7 inch colour display and the large high and low pressure gauges keep the operator up to date during the complete procedure.

- Fully-automatic – no manually operated valves
- Powerful compressor with a capacity of 500 g/min
- Extra large dryer filter cartridge of 700cc
- 21 languages
- Visual and acoustic signals in case of error messages and upon completion

#### **Professional refrigerant management with evaluation of recovery and charge volume:**

- Integrated printer for detailed reports
- Show results via USB, Bluetooth on PC (in preparation)

#### **Deep Recovery Function – total recovery saves costs and protects the environment:**

The intelligent electronic control of refrigerant weight, pressure and temperature guarantees a minimum of refrigerant waste at the service process.

- The unit complies with SAE J2788 Standard
- Maximum accuracy during recovery and flushing is based on +/- 15 gram
- 99% of the refrigerant is evacuated from vehicle and hoses
- Double-stage vacuum pump with delivery volume of 170 l/min

**BAC 4100a**

**81 34 2 286 739**

# r R134a.

## Additional Features:

- Integrated flushing program combined with optional flushing kit. The flushing process removes residue of lubricants and other fluids efficiently
- Automatic UV dye injection
- Optional connection to ASA network via LAN gateway (in preparation)

## Quality standard guarantee an unlimited AC service:

- Automatic air purge and cleaning of non condensable gases
- Shock resistant refrigerant scale for precise determining of refrigerant volume, accuracy of  $\pm 5$  g
- Vacuum time programmable

## Automatic Oil Management:

- Two separate lubrication circuits for PAG and POE oil to also service hybrid vehicles
- Three separate operating electronic scales for used and clean oil bottles, as well as UV-dye
- Hermetically closed oil bottles prevent any contamination with moisture and dust

## Technical Data:

Refrigerant	R134a
Display	5,7 inch TFT, 320 x 240 Pixel VAG color display
Alphanumeric keypad with function keys	
Manometers	EN837-1, 100 mm
Manual valves	No
Service hoses	2.50 m
Couplings	SAE J2196
Printer	Yes
USB port	2
SD card slot	Yes
Hermetic compressor	3/8 HP
Vacuum pump	170 l/min (50 Hz) 198 l/min (60 Hz)
Internal storage vessel	9.09 Kg
Filter for dryer	700 cc
Oil bottles	2 x 250 ml
UV dye bottle	1 x 250 ml
Dimensions	107 x 61 x 76 cm
Weight	107 kg
Voltage supply	230 V, 50/60 Hz



Hermetically closed oil and UV-dye bottles ensure moisture free and clean storage



Operating panel with 5,7 inch color display and integrated printer

## Scope of Delivery:

- Fully-automatic AC service unit for R134a
- High/low pressure hoses (2.5m)
- Quick couplers (SAE J2196)
- 2 clean oil bottles
- 1 UV dye bottle
- Calibration weight to check oil and refrigerant scale
- Multi language user manual
- Quick start reference
- Thermal paper for printer
- Safety kit: safety goggles and gloves
- Protective dust hood

## Special Accessory:

Flushing kit 81 34 2 286 908

# BAC 5100yf: AC service unit for R1234yf. Integrated refrigerant identifier.



## Fully automatic service unit:

- Recovery function
- Vacuum function
- Leak test
- Purging of non condensable gases
- Clean oil injection (separate bottles for PAG and POE oil) with electronic scale
- UV dye injection with electronic scale
- Refrigerant charge function

## Additional features:

- Hose clearing function
- Oil purge function with electronic scale
- Internal air flow control
- Software Windows Embedded CE
- Flushing function (optional flushing kit)

**As an alternative to fully automatic all steps can be selected individually for a manual controlled sequence.**

**Safe, climate change friendly, efficient.**

**New standard to service R1234yf.**

## Maximum Safety:

- Certified by TÜV Rheinland
- All hoses and connection elements comply with SAE J2888 and are certified by independent institutions
- Designed to eliminate any inflammation by potential electric sources
- Service couplings with dead space ventilation ensure that no refrigerant will leak

## Easy to use:

- Automatic program flow with visual and acoustic signals in case of error messages and upon completion
- Large 5,7 inch colour display with 21 languages available
- High and low pressure gauges with 100mm diameter easily readable
- Plastic film keyboard
- Automatic UV dye injection
- Automatic oil management with very accurate injection of PAG- and POE-oils by separate lubrication circuits
- Designed for minimum maintenance and maximum serviceability
- Vacuum pump oil and internal filter are easy to replace
- Oil/dye injection bottles are easily accessible and are suspended with magnetic connectors
- Refrigerant level check automatically activates the tank refill program after plugging in the new bottle

## Top Quality:

- Precision rate of  $\pm 15$  gram for filling and recovering functions achieved by integrated pressure and temperature control of refrigerant
- 2 separate lubrication circuits prevent a cross contamination of PAG and POE oil
- Separate injection of UV dye and lubricants
- Hermetically closed oil and UV-dye bottles ensure moisture free and clean storage
- Automatic internal connections and service hose clearing
- Auto-test during start procedure

**BAC 5100yf**

**81 34 2 286 325**

**Efficiency in comparison to standard units:**

- Service time can be reduced by 20 minutes thanks to the unique „deep recovery“ function (double-stage vacuum pump with high performance and a delivery volume of 170 l/min)
- 10% more refrigerant recovery from AC system of vehicle
- 80% better recycling minimizing loss of refrigerant
- ASA network connection on Dealer Management System for professional refrigerant management (in preparation)
- Automatic warning system to alert maintenance and filter change

**Reducing environmental impact:**

- Automatic drain of non condensable gases and cleaning of oils
- *Deep recovery function*: at least 95% of refrigerant is recovered from the AC system of vehicle and hoses

Technical Data:	
Refrigerant	R1234yf
Display	5,7 inch TFT, 320 x 240 pixel VAG colour display
Alphanumeric keypad with function keys	
Manometers	EN 837-1, 100 mm
Manual valves	No
Service hoses	2.50 m
Couplings	according to SAE J2888
Printer	Yes
USB port	2
SD card slot	Yes
Hermetic compressor	3/8 HP
Vacuum pump	170 l/min (50 Hz) 198 l/min (60 Hz)
Internal storage vessel	9.09 kg
Filter for dryer	700 cc
Oil bottles	2 x 250 ml
UV dye bottle	1 x 250 ml
Dimensions	107 x 61 x 76 cm
Voltage supply	230 V, 50/60 Hz
Weight	107 kg
Certificates	CE, TÜV Rheinland, SAE J2099, SAE J2843

**The BAC 5100yf safety package:****Integrated refrigerant identifier**

- Preventing contamination of the service station if vehicle contains unclean refrigerant

**Automatic monitoring of the gas concentration inside the service unit**

- Automatic air ventilation is controlled by electronic flow meter, which checks the unit with known limits to keep the gas concentrations below the inflammable level
- Regular leakage check by performing vacuum and pressure test with automatic power switch off in case of leak

**Safety mode for maintenance**

- Electric functions are automatically switched off
- Automatic leak detection when changing filter and vacuum pump oil

German inspection authority TÜV Rheinland released the unit according to the German automotive industry association and the European Pressure Equipment Directive (PED, 97/23/EC) regarding safety, reliability and efficiency.

**Scope of Delivery:**

- Fully-automatic AC service unit for R1234yf
- Integrated refrigerant identifier
- High/low pressure hoses (2.5m)
- Quick couplers (SAE J2888)
- 2 clean oil bottles
- 1 UV dye bottle
- Calibration weight to check oil and refrigerant scale
- Multi language user manual
- Quick start reference
- Thermal paper for printer
- Safety: protective goggles and gloves
- Protective dust hood



## ACC 100:

Active Cruise Control (ACC) Adjustment System. 34-35

## Leakfinder®:

For leak diagnosis of sealed systems. 36-37





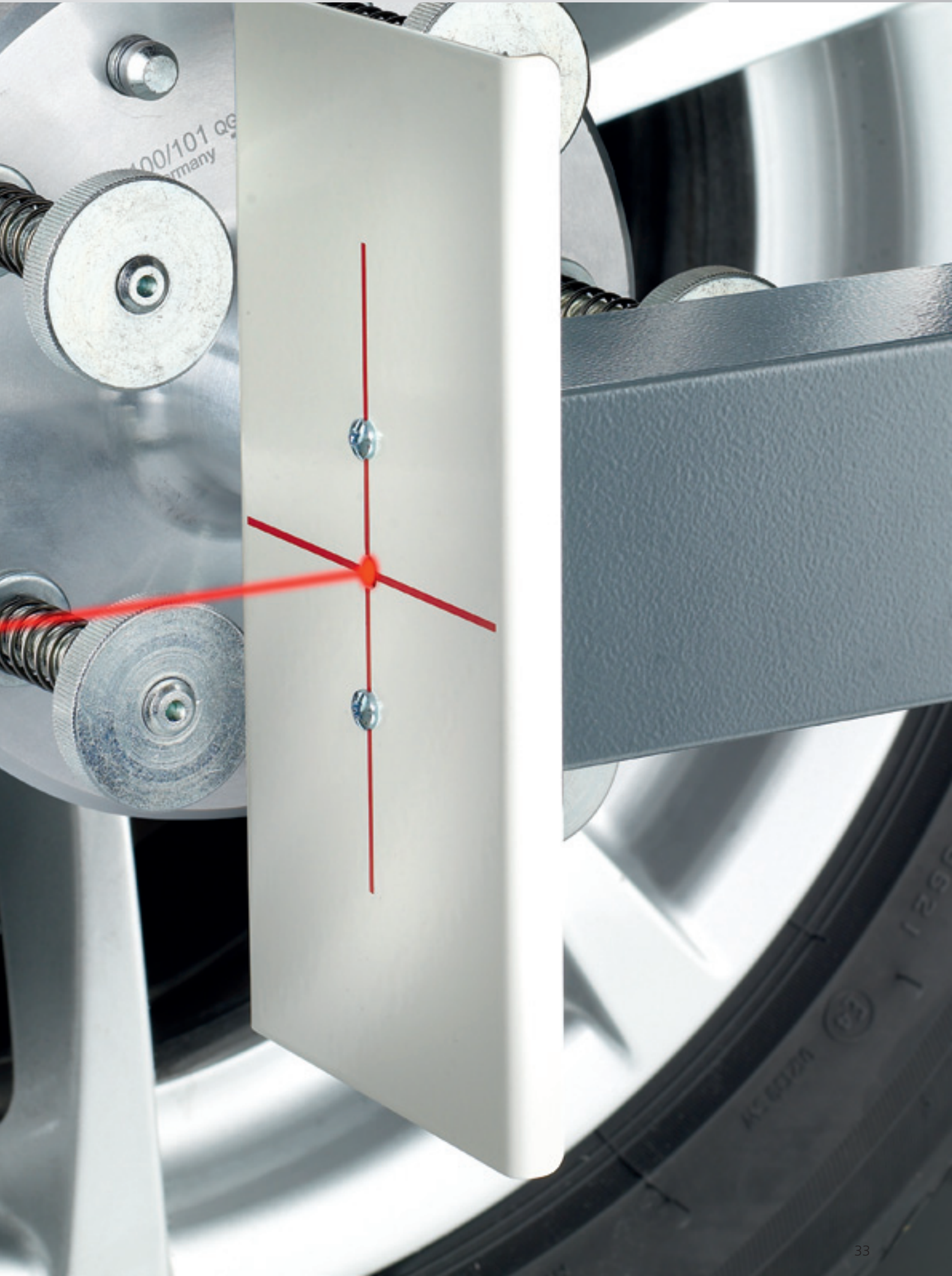

# ACC 100: Active Cruise Control (ACC) Adjustment System



## The ACC 100 from Bosch can be used to adjust ACC sensors.

Active Cruise Control sensor adjustment is performed with the aid of precision laser technology.

This involves the adjuster measuring the exact position of the sensor with respect to the drive axis. On the side of the vehicle, the wheel laser and mirror are precisely aligned with the drive axis by way of the slotted diaphragm. The calibration mirror can then be exactly centred with the thrust line on the basis of the angular positions.

### Tools additionally required:

Refer to BMW repair instructions.

### Scope of Delivery:

#### Adjustment system

81 31 0 442 898

- Incl.:
- Mirror, complete
  - Wheel laser (with batteries)
  - Slotted diaphragm
  - Bracket for rail adjustment

### Special Accessories:

Ground rail

81 31 0 442 899

Rough adjuster

BB-Nr. 1 687 023 317

### Technical Data:

Wheel laser	Laser class 2
Rough adjuster laser	Laser class 2
Wavelength	650 nm + 10 nm
Radiation	0.5 mW - 1 mW
Spot size	Ø 3 mm
Temperature range	-10 °C bis +40 °C
Power supply	3 V - 6 V



Laser safety regulations must be observed.

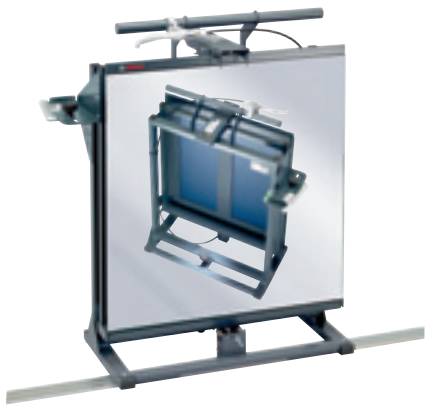

③ Mirror, complete:  
Fine adjustment of  
ACC sensor by  
determination of drive axis



① Rough adjuster



④ Slotted diaphragm:  
Vertical mirror alignment

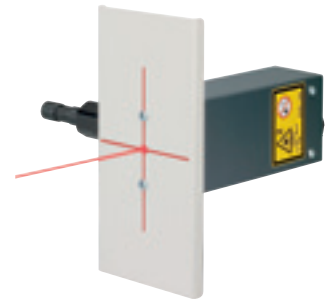

⑤ Wheel laser:  
Horizontal mirror alignment

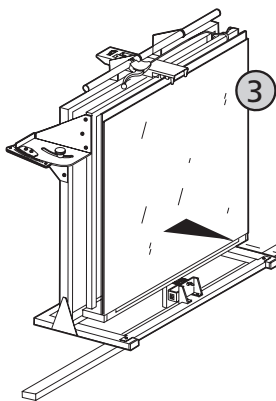
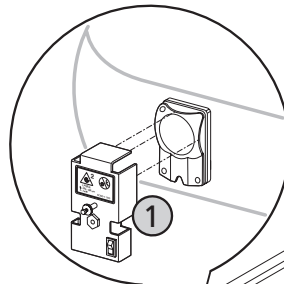

②

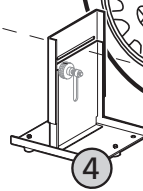

④

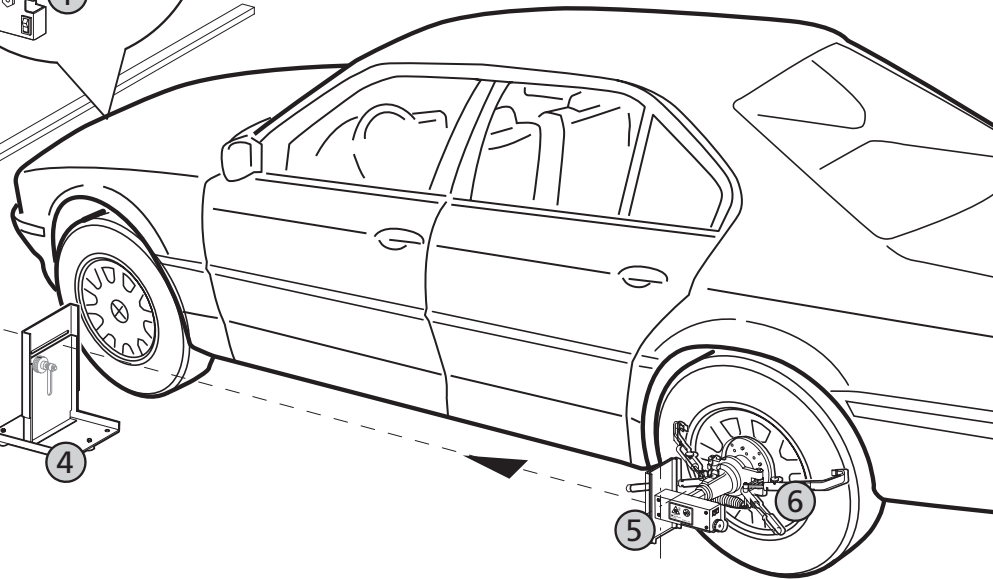

⑤

⑥



# Leakfinder®:

## For leak diagnosis of sealed systems.



**Leak size and location can be determined in 2 operating modes. The device with the optional accessory is suitable for leak-testing on fuel and exhaust systems.**

**The generated smoke can also be used for detecting leaks on door and window seals.**

Only inert gas (non-flammable, CO<sub>2</sub> or nitrogen) may be used for leak-testing on the fuel system. The pressure gas bottle of the "Inert Gas Pack Kit" is supplied empty and must be filled at a specialist outlet for inert gas shielded arc welding equipment.

- Leakfinder® is recommended for Evaporative Emissions System (EVAP) leak-testing, as well as other systems, on all BMW vehicles
- With this machine it is possible to check closed loops like intake and exhaust systems and also to find wind & water leaks
- There is an integrated test mode which allows you to test closed loops without smoke and to only add smoke if necessary. The control of the smoke volume is helpful to find smaller leaks
- It is designed to be safe for vehicle systems and will not void factory warranties

**Leak detector "BMW Smoke Tester"**

**Leakfinder®**

**81 31 2 353 954**



Use white light to find the smoke

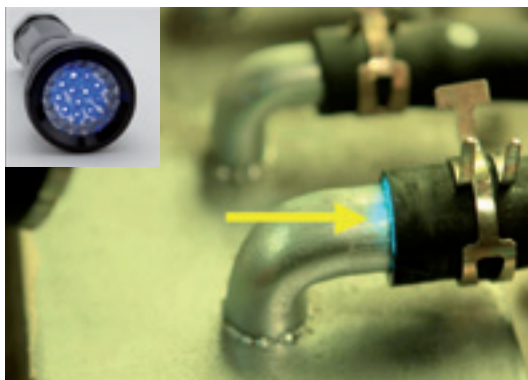

Use UV light and yellow glasses to find the dye

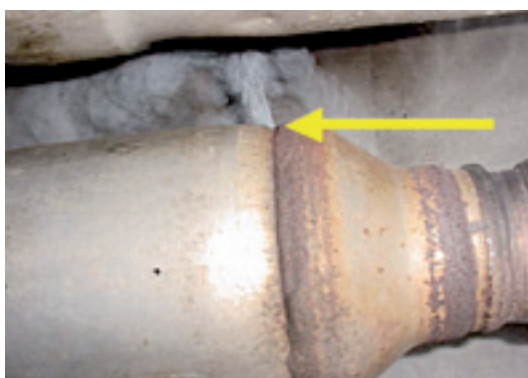

Leakfinder® can detect also leaks in the exhaust pipe system

**Technical Data:**

Operating pressure	0.035 bar
Compressed air connection	3.4 - 12 bar
Power supply	100-240 V (50-60 / 5 Hz/A)
Weight approx.	6.1 kg
Hose length	2,400 mm
Tank for UltraTraceUV® smoke solution	355 ml

**Special Accessories:**

Tank adapter	83 30 2 318 573
LDP plug for US vehicles	83 30 0 495 345

**Scope of Delivery:**

- Smoke generator "BMW Smoke Tester" with hose and nozzle
- 2 UltraTraceUV® bottles
- Switch-selectable torch with white and UV light and special goggles
- Smoke diffuser for leak detection on door seals, etc.
- Tapered adapter for introducing smoke e.g. into exhaust systems (dia. 25 mm to 89 mm)
- Power pack
- "Inert Gas Pack Kit" for leak detection in fuel systems
- Padding for handle
- Compressed-air coupling, plug-in nipple
- Compressed-air coupling, coupling



## Special Tool Cabinet 350:

Combinable basic elements.

40

## Special Tool Cabinet 550:

Additional element for cables.

41

## Axle and Transmission Lifters.

42

## Engine and Transmission Supports.

43

BMW Se  
Special

Service  
Tools

# Special Tool Cabinet 350: Combinable basic elements.



The special tool cabinets with vertical pull-out drawer were developed by Bosch for the storage of special tools.

Up to 200 special tools or items weighing 200 kg can be stored in each cabinet. The storage locations for the special tools are indicated in the repair instructions.

**Scope of Delivery:**

Base body with magnetic pocket for contents list.

**Special Accessories:**

Back panel set	81 61 2 337 571
Side panel set	81 61 2 337 573
Wall bracket 350	81 61 2 337 574

Technical Data:	
Dimensions (W x D x H)	370 x 1,125 x 2,380 mm
Base area	0.35 m <sup>2</sup>
Drawer	680 mm

**Special Tool Cabinet 350**

**81 61 2 334 661**

Suitable for expansion (also in combination with cabinet 550 for cables):





## Special Tool Cabinet 550: Additional element for cables.



**The wider cabinet 550 is designed as an extension to the standard cabinets 350 for the storage of probes and test cables.**

Vertical cabinet pull-out with folding elements for hanging items on both sides. Integrated level adjuster.

### Scope of Delivery:

Base body with swivel frame and magnetic pocket for contents list.

**Special Tool Cabinet 550**

**81 61 2 336 941**

### Special Accessories:

Back panel set	81 61 2 337 572
Side panel set	81 61 2 337 573
Wall bracket 550	81 61 2 337 575
5x locking system	81 61 2 337 565
10x locking system	81 61 2 337 567

### Technical Data:

Dimensions (WxDxH)	625 x 1,125 x 2,380 mm
Base area	0.55 m <sup>2</sup>
Drawer	680 mm



**Coming soon: information on request "Infrared" locking system as special accessory for cabinets 350 and 550.**

# Axle and Transmission Lifters.

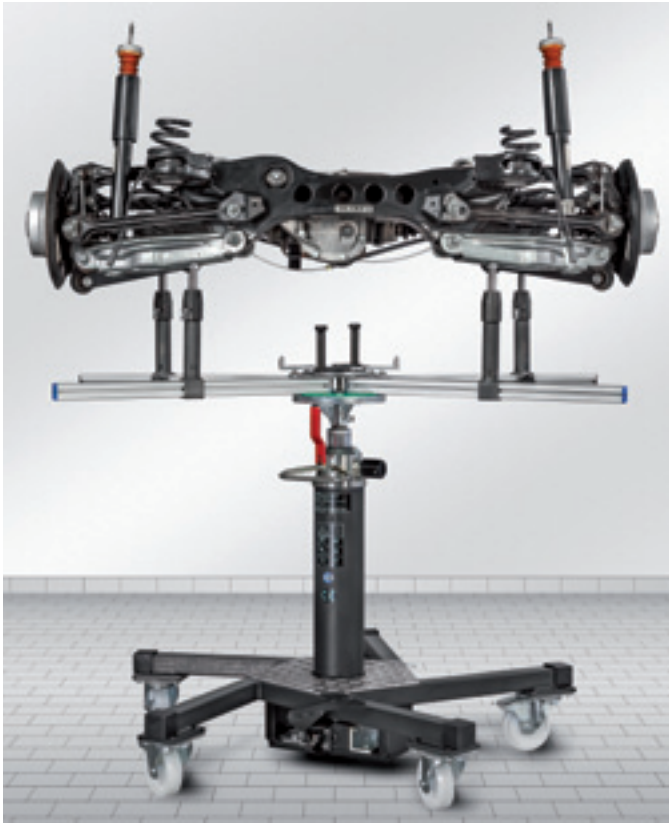

## For lifting transmissions and axles of all types:

The universal hydraulic lifter with axle support is designed for lifting and moving transmission units and axles. Guaranteed stability and mobility whatever the lifting height.

- Hydraulic cylinder with integrated foot pump
- Rotary valve for infinitely variable lowering
- Mobile with extra-sturdy trolley
- 5 rollers (3 braked)
- Set of bolts (for attaching cylinder to trolley)
- Directions for use in repair instructions

**Universal Hydraulic Lifter**      81 22 2 219 012  
**Universal Axle Support**        83 30 0 495 567

### Technical Data:

Weight	approx. 100 kg
Height min./max.	890 / 1,895 mm
Lifting height	1,005 mm
Loadbearing capacity	600 kg
Trolley diameter	1,200 mm



Universal with appropriate supports



Safety latch (red) with rotary valve (black)

# Engine and Transmission Supports.



## For holding engines and gearboxes:

Compatible with existing supports from the current BMW special tool range.

- Universal support with 2 short clamping bars and 4 long clamping bars
- Infinitely variable rotation via hand crank (worm gear, 60:1 transmission ratio, self-locking)
- Hydraulic foot pump
- Two steering rollers and two castors for mobility in the workshop
- Storage space for small items and tools

## Environmental protection:

- Fluid collector trough with drainage system
- Automatic anti-lowering safeguard in the event of fluid escape

**Engine and Transmission Support** 83 30 0 495 187

**Support arm with holding plate** 83 30 0 495 196

## Technical Data:

Weight	100 kg
Dimensions (L x H x W)	1,200 x 1,000 x 850 mm
Static loadbearing capacity	600 kg

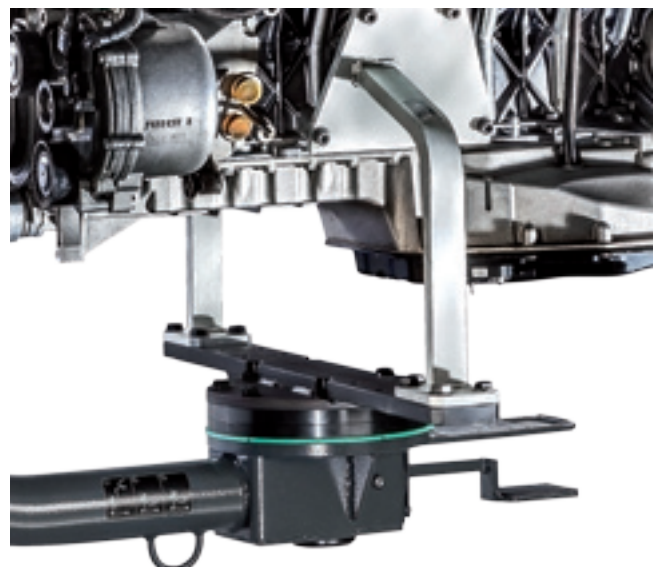

360° infinite adjustment – easy movement in all directions

# Beissbarth Service worldwide



## Service from Beissbarth Munich:

- Immediate telephone support
- Rapid replacement parts deliveries
- Individual maintenance contracts

## Factory customer service:

Beissbarth and certified partner companies provide on-site assistance with installation, instruction, equipment assembly and maintenance – with partners in more than 90 countries around the world.

## Training Centre:

Instruction and training at STC of Robert Bosch GmbH, 73207 Plochingen

## Software Centre:

Technical documentation, specified vehicle data and marketing material for immediate download:  
[www.beissbarth.com](http://www.beissbarth.com)



Subject to technical modification and changes to scope of delivery.  
Pictures may sometimes show special accessories or similar versions. Please contact your Beissbarth dealer for a binding up-to-date quotation.

Beissbarth GmbH  
A Bosch Group Company  
Hanauer Strasse 101  
80993 Muenchen (Munich, Bavaria)  
Germany

Tel. +49-89-149 01-0  
Fax +49-89-149 01-240

[www.beissbarth.com](http://www.beissbarth.com)  
[sales@beissbarth.com](mailto:sales@beissbarth.com)